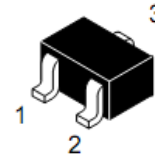
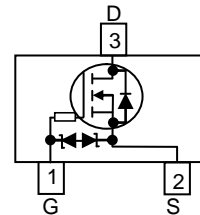

WNM6002
Single N-Channel, 60V, 0.30A, Power MOSFET
[Http://www.sh-willsemi.com](http://www.sh-willsemi.com)

V _{DS} (V)	R _{ds(on)} (Ω)
60	1.4@ V _{GS} =10V
	1.7@ V _{GS} =4.5V
ESD Rating:2000V HBM	

SOT-323
Descriptions

The WNM6002 is N-Channel enhancement MOS Field Effect Transistor. Uses advanced trench technology and design to provide excellent R_{DS(ON)} with low gate charge. This device is suitable for use in DC-DC conversion, power switch and charging circuit. Standard Product WNM6002 is Pb-free and Halogen-free.

Features

- Trench Technology
- Supper high density cell design
- Excellent ON resistance for higher DC current
- Extremely Low Threshold Voltage
- Small package SOT-323

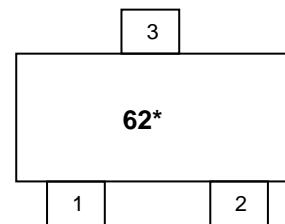
Pin configuration (Top view)

62 = Device Code
 * = Month (A~Z)

Marking
Applications

- Driver for Relay, Solenoid, Motor, LED etc.
- DC-DC converter circuit
- Power Switch
- Load Switch
- Charging

Order information

Device	Package	Shipping
WNM6002-3/TR	SOT-323	3000/Reel&Tape

Absolute Maximum ratings

Parameter		Symbol	10 s	Steady State	Unit
Drain-Source Voltage		V_{DS}	60		V
Gate-Source Voltage		V_{GS}	± 20		
Continuous Drain Current ^{ad}	$T_A=25^\circ\text{C}$	I_D	0.30	0.28	A
	$T_A=70^\circ\text{C}$		0.24	0.22	
Maximum Power Dissipation ^{ad}	$T_A=25^\circ\text{C}$	P_D	0.37	0.31	W
	$T_A=70^\circ\text{C}$		0.23	0.20	
Continuous Drain Current ^{bd}	$T_A=25^\circ\text{C}$	I_D	0.27	0.24	A
	$T_A=70^\circ\text{C}$		0.21	0.19	
Maximum Power Dissipation ^{bd}	$T_A=25^\circ\text{C}$	P_D	0.29	0.23	W
	$T_A=70^\circ\text{C}$		0.18	0.14	
Pulsed Drain Current ^c		I_{DM}	1.0		A
Operating Junction Temperature		T_J	-55 to 150		$^\circ\text{C}$
Lead Temperature		T_L	260		$^\circ\text{C}$
Storage Temperature Range		T_{stg}	-55 to 150		$^\circ\text{C}$

Thermal resistance ratings

Parameter		Symbol	Typical	Maximum	Unit
Junction-to-Ambient Thermal Resistance ^a	$t \leq 10$ s	$R_{\theta JA}$	245	335	$^\circ\text{C/W}$
	Steady State		325	395	
Junction-to-Ambient Thermal Resistance ^b	$t \leq 10$ s	$R_{\theta JA}$	375	430	
	Steady State		445	535	
Junction-to-Case Thermal Resistance		$R_{\theta JC}$	260	300	

a Surface mounted on FR-4 Board using 1 square inch pad size, 1oz copper

b Surface mounted on FR-4 board using minimum pad size, 1oz copper

c Pulse width < 380 μs

d Maximum junction temperature $T_J=150^\circ\text{C}$.

Electronics Characteristics (Ta=25°C, unless otherwise noted)

Parameter	Symbol	Test Conditions	Min	Typ	Max	Unit
OFF CHARACTERISTICS						
Drain-to-Source Breakdown Voltage	BV_{DSS}	$V_{GS} = 0\text{ V}, I_D = 250\mu\text{A}$	60			V
Zero Gate Voltage Drain Current	I_{DSS}	$V_{DS} = 60\text{ V}, V_{GS} = 0\text{ V}$			1	μA
Gate-to-source Leakage Current	I_{GSS}	$V_{DS} = 0\text{ V}, V_{GS} = \pm 20\text{ V}$			± 5	μA
ON CHARACTERISTICS						
Gate Threshold Voltage	$V_{GS(TH)}$	$V_{GS} = V_{DS}, I_D = 250\mu\text{A}$	0.8	1.3	2	V
Drain-to-source On-resistance ^{b, c}	$R_{DS(on)}$	$V_{GS} = 10\text{ V}, I_D = 0.37\text{ A}$		1.4	2.0	Ω
		$V_{GS} = 4.5\text{ V}, I_D = 0.2\text{ A}$		1.7	2.6	
Forward Transconductance	g_{FS}	$V_{DS} = 15\text{ V}, I_D = 0.25\text{ A}$		0.42		S
CAPACITANCES, CHARGES						
Input Capacitance	C_{ISS}	$V_{GS} = 0\text{ V},$ $f = 1.0\text{ MHz},$ $V_{DS} = 25\text{ V}$		23.37		pF
Output Capacitance	C_{OSS}			7.33		
Reverse Transfer Capacitance	C_{RSS}			5.2		
Total Gate Charge	$Q_{G(TOT)}$	$V_{GS} = 10\text{ V},$ $V_{DD} = 30\text{ V},$ $I_D = 0.37\text{ A}$		1.2		nC
Threshold Gate Charge	$Q_{G(TH)}$			0.15		
Gate-to-Source Charge	Q_{GS}			0.21		
Gate-to-Drain Charge	Q_{GD}			0.12		
SWITCHING CHARACTERISTICS						
Turn-On Delay Time	$t_d(ON)$	$V_{DD} = 30\text{ V}, I_D = 0.2\text{ A},$ $V_{GEN} = 10\text{ V}, R_G = 10\ \Omega$		7.6		ns
Rise Time	t_r			5.1		
Turn-Off Delay Time	$t_d(OFF)$			24.6		
Fall Time	t_f			10		
BODY DIODE CHARACTERISTICS						
Forward Voltage	V_{SD}	$V_{GS} = 0\text{ V}, I_S = 0.3\text{ A}$		0.9	1.5	V

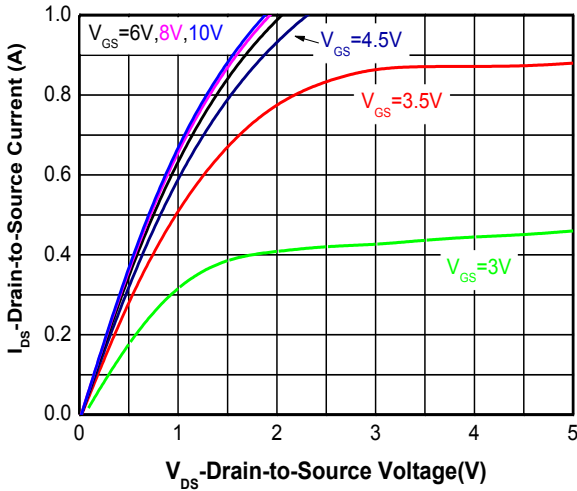
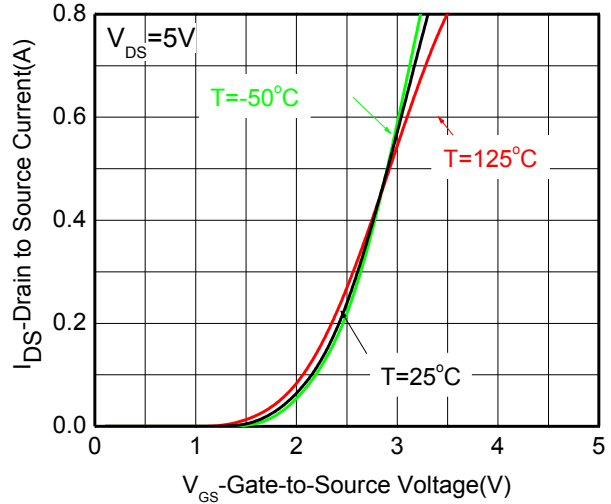
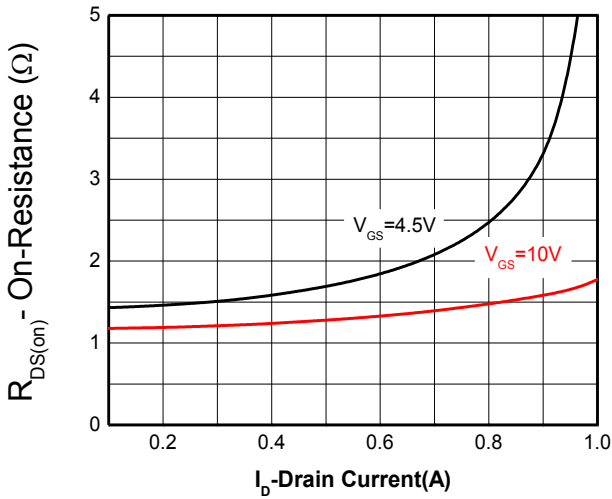
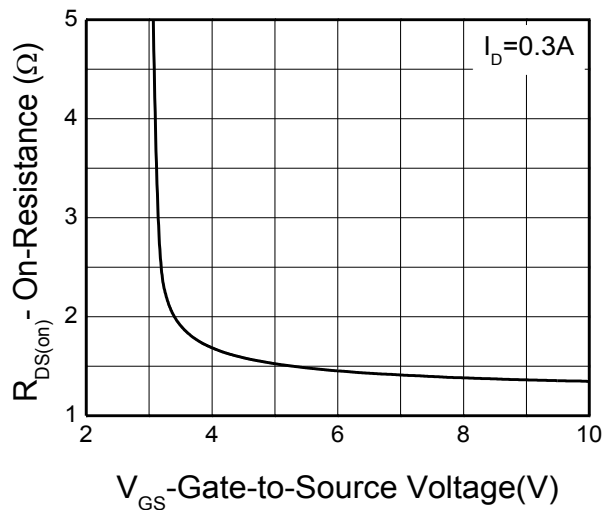
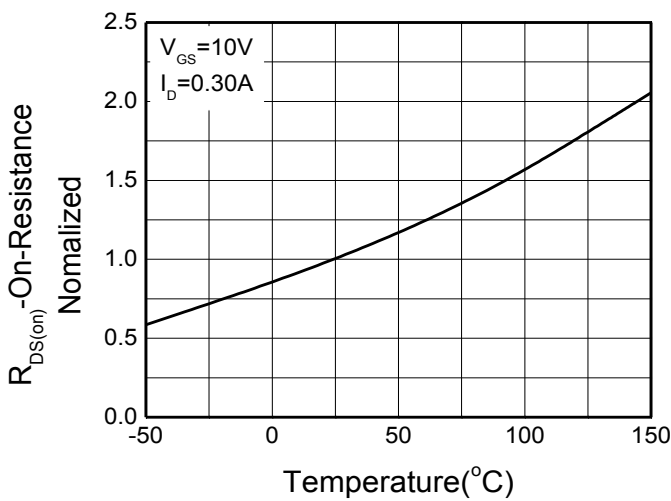
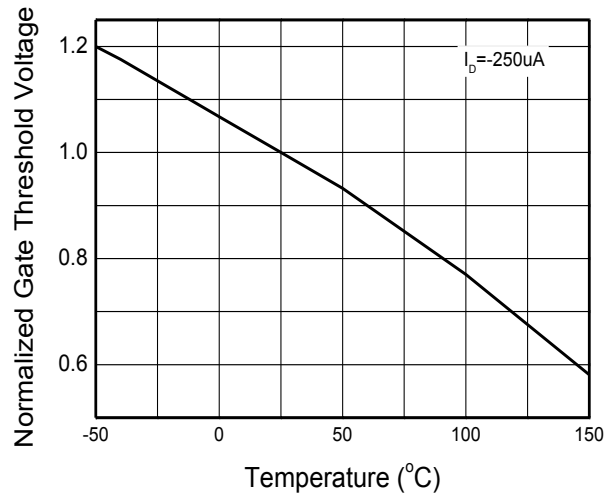
Typical Characteristics (Ta=25°C, unless otherwise noted)

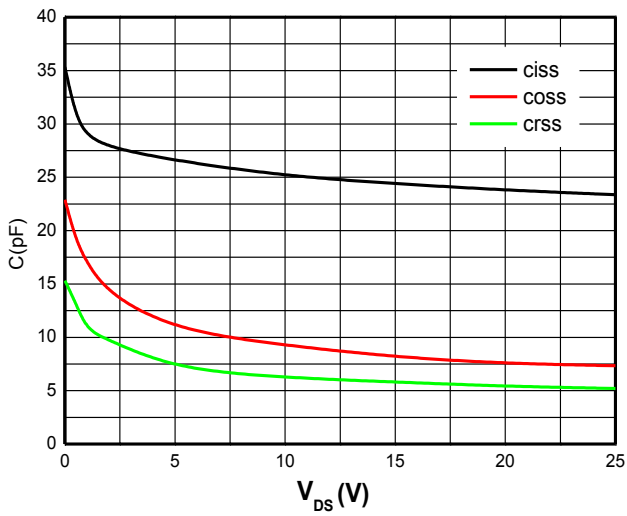
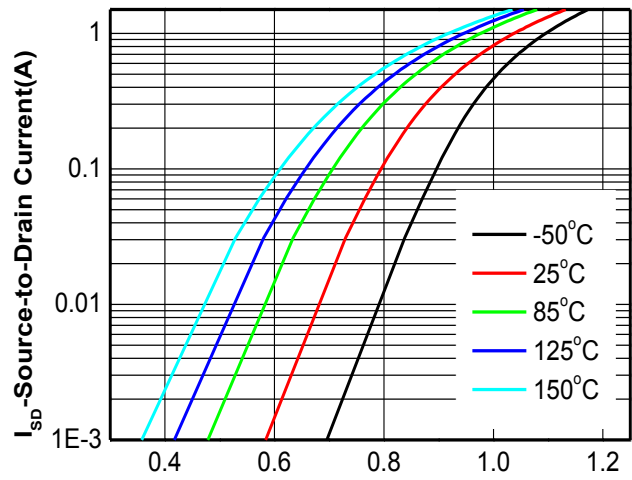
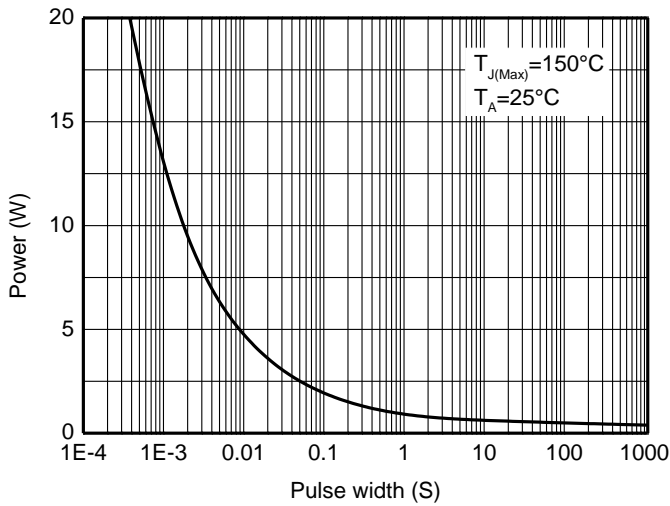
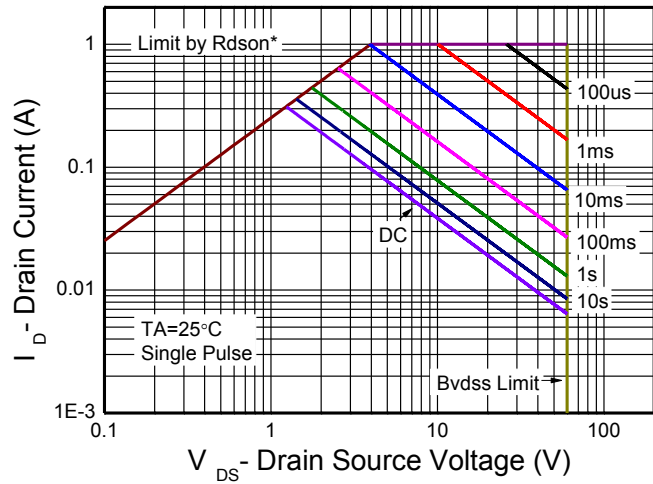
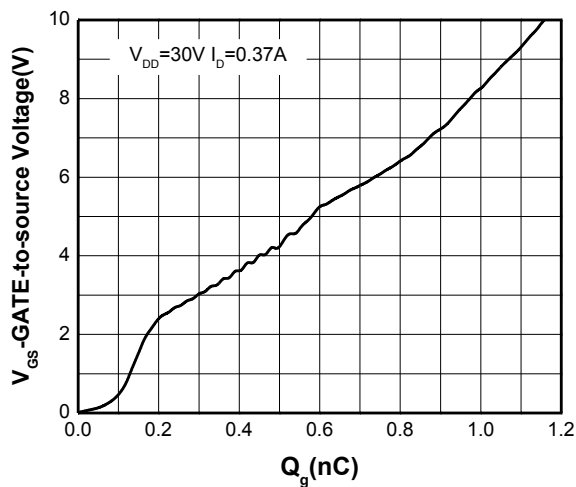
Output characteristics

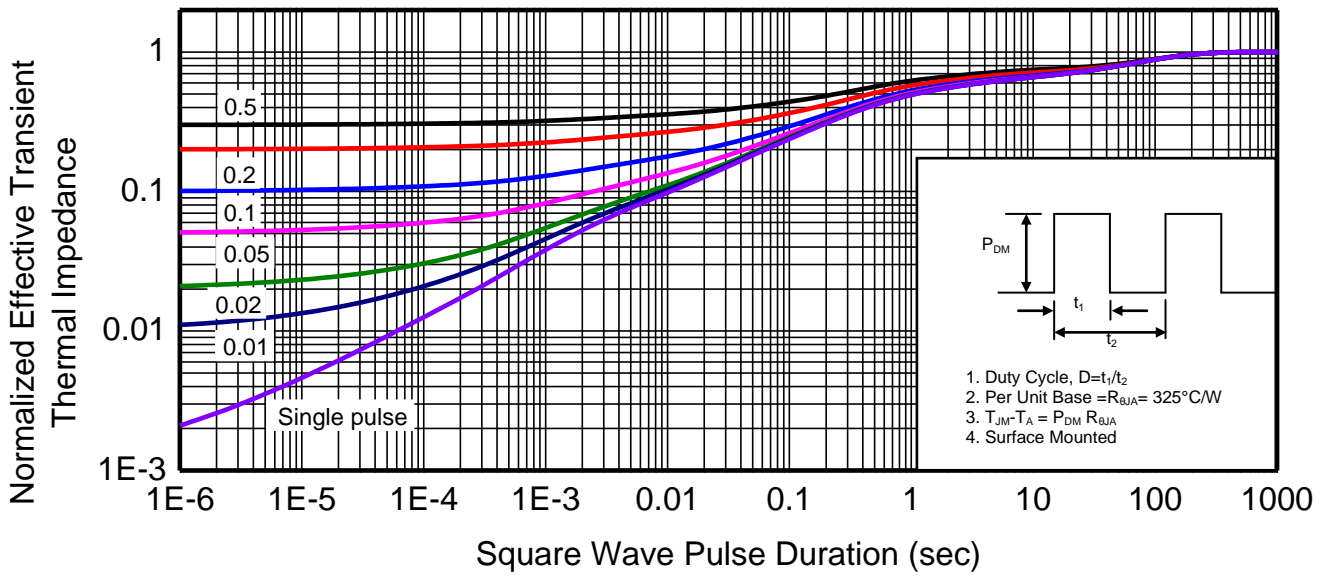
Transfer characteristics

On-Resistance vs. Drain current

On-Resistance vs. Gate-to-Source voltage

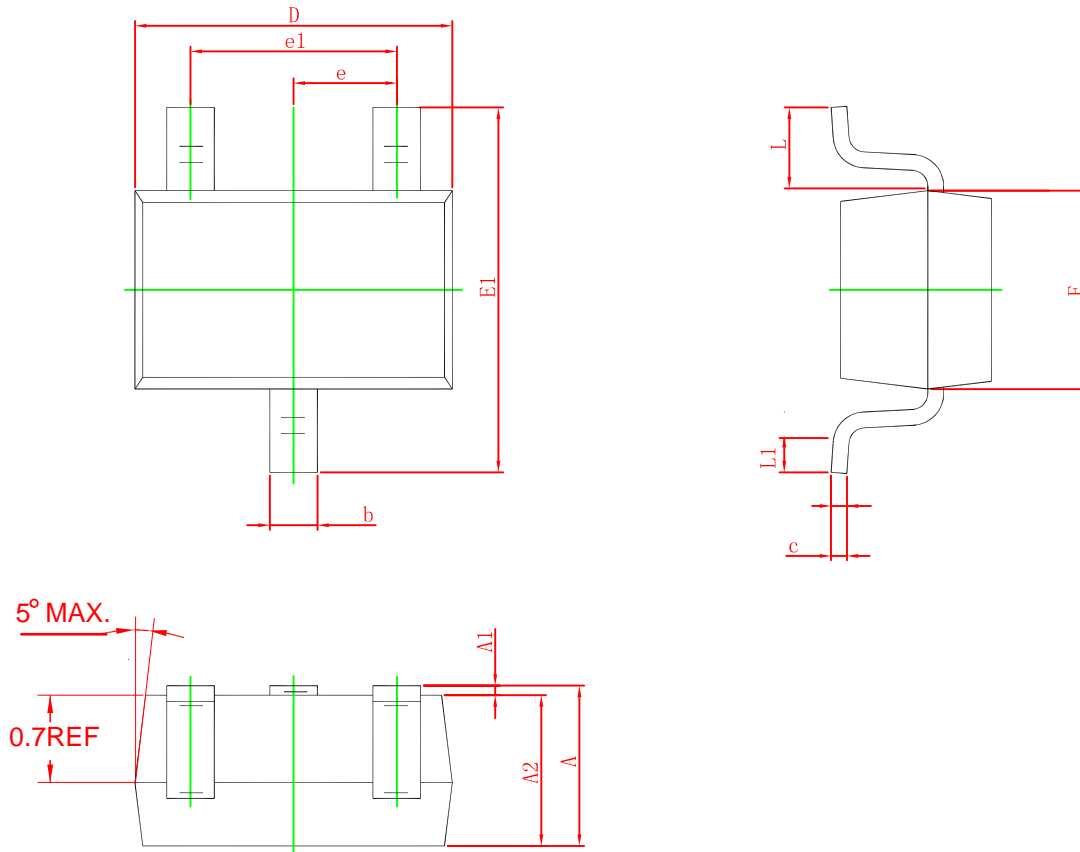
On-Resistance vs. Junction temperature

Threshold voltage vs. Temperature

Capacitance

Body diode forward voltage

Single pulse power

Safe operating power

Gate Charge Characteristics



Transient thermal response (Junction-to-Ambient)

1. Duty Cycle, $D=t_1/t_2$
2. Per Unit Base $=R_{\theta JA}= 325^{\circ}\text{C/W}$
3. $T_{JM}-T_A = P_{DM} R_{\theta JA}$
4. Surface Mounted

Package outline dimensions
SOT-323

Symbol	Dimensions in millimeter		
	Min.	Typ.	Max.
A1	0.1MAX.		
A2	0.800	0.900	1.000
b	0.250	0.300	0.350
c	0.050	0.100	0.150
D	1.900	2.000	2.100
E	1.150	1.250	1.350
E1	2.000	2.100	2.200
e1	1.200	1.300	1.400
L1	0.2MIN.		